

# RESIDENTIAL ULTRA LOW NO<sub>x</sub> GAS WATER HEATER

• INSTALLATION • OPERATION • SERVICE • MAINTENANCE •

GAS-FIRED

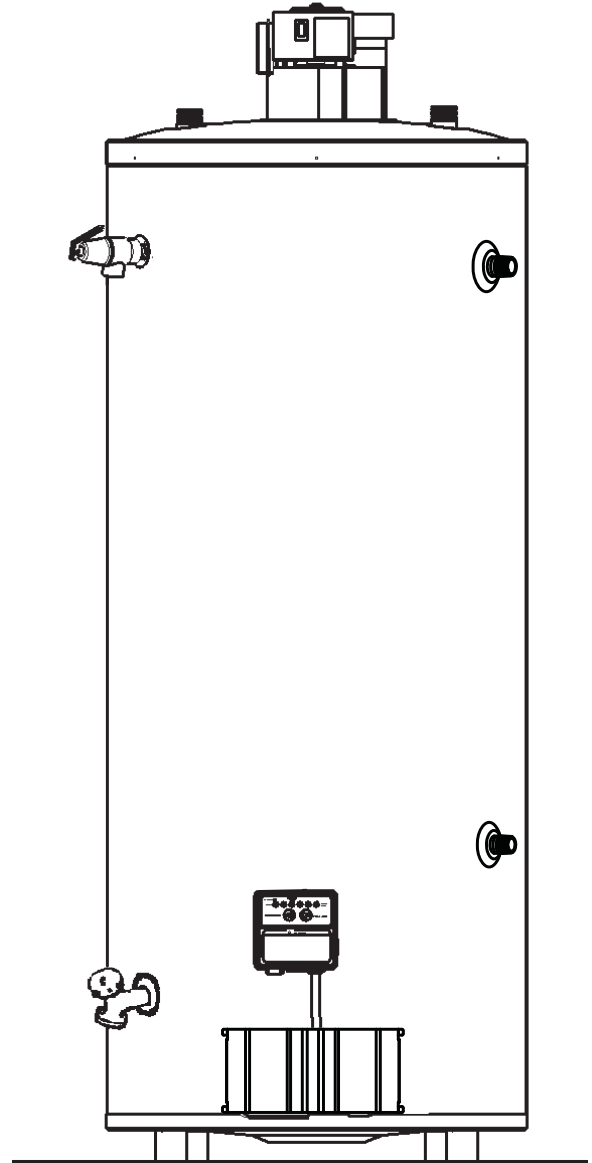

**WARNING:** If the information in these instructions is not followed exactly, a fire or explosion may result causing property damage, personal injury or death.

- Do not store or use gasoline or other flammable vapors and liquids in the vicinity of this or any other appliance.
- **WHAT TO DO IF YOU SMELL GAS**
  - Do not try to light any appliance.
  - Do not touch any electrical switch; do not use any phone in your building.
  - Immediately call your gas supplier from a neighbor's phone. Follow the gas supplier's instructions.
  - If you cannot reach your gas supplier, call the fire department.
- Installation and service must be performed by a qualified installer, service agency or the gas supplier.

**CAUTION**

TEXT PRINTED OR OUTLINED IN RED CONTAINS INFORMATION RELATIVE TO YOUR SAFETY. PLEASE READ THOROUGHLY BEFORE INSTALLING AND USING THIS APPLIANCE.

PLACE THESE INSTRUCTIONS ADJACENT TO HEATER  
AND NOTIFY OWNER TO KEEP FOR FUTURE REFERENCE.

# ROUGH-IN DIMENSIONS

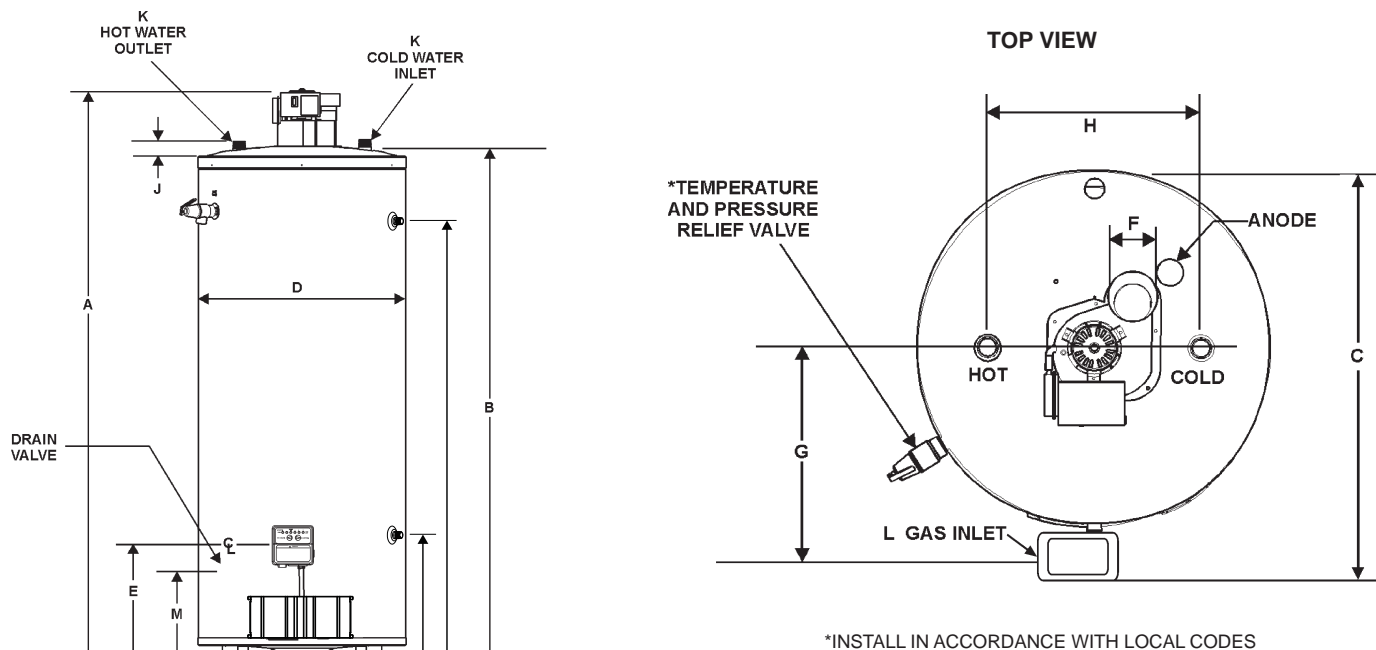

FIGURE 1.

TABLE 1, DIMENSIONS

Units	A	B	C	D	E	F	G	H	J	K	L	M	P	Q
<b>Inches</b>	66 5/8	58 3/4	30 15/16	27 3/4	15 1/4	4	15 3/4	16	1 1/4	1 1/4	1/2	12 1/4	24 7/8	53 7/8
<b>CM</b>	169.22	149.23	76.99	70.5	38.6	10.2	40.0	40.6	3.2	NPT	NPT	31.1	63.2	136.8

TABLE 2, RECOVERY RATINGS ARE BASED ON 80% THERMAL EFFICIENCY

INPUT RATE	Recovery in US Gallons/hr or Liters/hr at Indicated Temperature Rise in Fahrenheit or Celsius																	
	°F	30	36	40	50	54	60	70	72	80	90	100	108	110	120	126	130	140
75,100 BTU/H	GPH	243	203	182	145	134	122	104	101	91	81	73	67	66	60	57	56	52
	°C	17	20	23	28	30	33	39	40	44	50	56	60	61	67	70	72	78
22 KW	LPH	920	767	688	549	509	460	392	381	344	306	277	254	251	228	217	213	199

TABLE 3, GAS AND ELECTRICAL CHARACTERISTICS

Manifold Pressure			Electrical Characteristics	
Type of gas	Inches W.C.	kPa	Voltz/Hz	Amperes
Natural Gas	4.0	1.12	120/60	<5

All Models: Maximum supply pressure = 14.0 in. W.C. (3.48 kPa)  
 Minimum supply pressure, Natural gas = 6 in. W.C. (1.49 kPa).  
 Minimum pressures must be maintained under both load and no load (static and dynamic) conditions.

## FOREWORD

The design of these models comply with the current edition of ANSI Z21.10.3/CSA 4.3 an automatic storage water heater.

Installation diagrams are found in this manual. These diagrams will serve to provide the installer with a reference for the materials and method of piping necessary. It is highly essential that all water and gas piping be installed as shown on the diagrams.

In addition to these instructions, the equipment shall be installed in accordance with those installation regulations in force in the local area where the installation is to be made. These shall be carefully followed in all cases. Authorities having jurisdiction should be consulted before installations are made.

The installation must conform with these instructions and the local code authority having jurisdiction. In the absence of local codes, installations should comply with the National Fuel Gas Code (ANSI Z223.1/NFPA

54) and the National Electric Code (NFPA 70). These publications are available from The National Fire Protection Association, 1 Batterymarch Park, Quincy, MA 02269

**Thank You** for purchasing this water heater. Properly installed and maintained, it should give you years of trouble free service.

Abbreviations Found In This Manual:

- CSA-Canadian Standards Association
- ANSI-American National Standards Institute
- NFPA-National Fire Protection Association
- AHRI-Air Conditioning, Heating and Refrigeration Institute
- UL-Underwriters Laboratories

This gas-fired water heater is design certified by Underwriters Laboratories Inc. under American National Standard/CSA Standard for Gas Water Heaters ANSI Z21.10.3•CSA 4.3 (current edition).

## GENERAL SAFETY



### ⚠️ WARNING

Read and understand instruction manual and safety messages before installing, operating or servicing this water heater.

Failure to follow instructions and safety messages could result in death or serious injury.

Instruction manual must remain with water heater.



### ⚠️ WARNING

#### Fire Hazard

For continued protection against risk of fire:

- Do not install water heater on carpeted floor.
- Do not operate water heater if flood damaged.

### ⚠️ DANGER

Water temperature over 125°F (52°C) can cause severe burns instantly resulting in severe injury or death.

Children, the elderly, and the physically or mentally disabled are at highest risk for scald injury.

Feel water before bathing or showering.

Temperature limiting valves are available.

Read instruction manual for safe temperature setting.

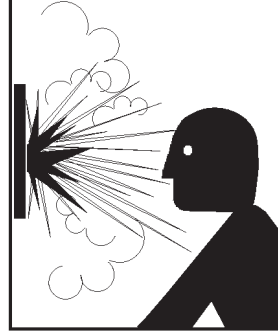
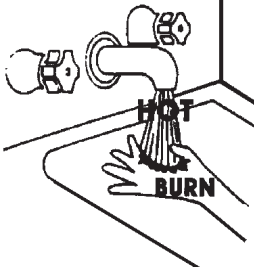

### ⚠️ WARNING

#### Explosion Hazard

- Overheated water can cause water tank explosion.
- Properly sized temperature and pressure relief valve must be installed in opening provided.

### ⚠️ WARNING

#### Fire or Explosion Hazard

- Avoid all ignition sources if you smell gas.
- Do not expose water heater control to excessive gas pressure.
- Use only gas shown on rating plate.
- Maintain required clearances to combustibles.
- Keep ignition sources away from faucets after extended period of non-use.



Read instruction manual before installing, using or servicing water heater.



### ⚠️ WARNING

#### Breathing Hazard - Carbon Monoxide Gas

- Install vent system in accordance with codes.
- Do not operate water heater if flood damaged.
- High altitude office must be installed above 7,700 ft. (2,347 m).
- Do not operate if soot buildup.
- Do not obstruct water heater air intake with insulating jacket.
- Do not place chemical vapor emitting products near water heater.
- Gas and carbon monoxide detectors are available.



Breathing carbon monoxide can cause brain damage or death. Always read and understand instruction manual.

### ⚠️ DANGER

#### Fire or Explosion Hazard

- Do not store or use gasoline or other flammable vapors and liquids in the vicinity of this or any other appliance.



### CAUTION

#### Improper installation and use may result in property damage.

- Do not operate water heater if flood damaged.
- Inspect and replace anode rod as needed.
- Install in location with drainage.
- Fill tank with water before operation.
- Be alert for thermal expansion.

Refer to instruction manual for installation and service.

# TABLE OF CONTENTS

	Page		Page
ROUGH-IN DIMENSIONS.....	2	Gas Piping.....	9
FOREWORD.....	2	Purging.....	10
GENERAL SAFETY INFORMATION		Gas Meter Size.....	10
Precautions.....	4	Gas Pressure Regulator.....	10
Preparing for the Installation.....	4	OPERATION.....	10
Grounding Instructions.....	4	To Operate The Heater.....	10
Chemical Vapor Corrosion.....	5	Heater Wiring.....	11
Extended Non-use Periods.....	5	Lighting Instructions.....	12
Insulation Blankets.....	5	Temperature Regulation.....	13
High Altitude Installations.....	5	Checking Venting.....	13
Circulating Pump.....	6	High Temperature Limit Switch.....	13
INSTALLATION INSTRUCTIONS		SERVICE INFORMATION.....	14-15
Required Ability.....	6	Main Burner and Igniter.....	14
Locating The Heater.....	6	Checking Gas Input.....	14
Clearances.....	6	Vent System.....	14
Hard Water.....	6	Blower Maintenance.....	15
Air Requirements.....	6-7	Relief Valve.....	15
Unconfined Space.....	7	Hot Water Odor.....	15
Confined Space.....	7	Winter Protection.....	15
Venting.....	7-8	Replacement Parts.....	15
Vent Connection.....	8	Draining and Flushing.....	15
Thermometers.....	8	CHECKLIST.....	15-16
Combination Water (Potable) and Space Heating.....	8	Condensation.....	16
Mixing Valves.....	8	Anode Rod Inspection.....	16
System Connections.....	9	Service and Repair.....	16
Relief Valve.....	9	TROUBLESHOOTING.....	17-19

## GENERAL SAFETY INFORMATION

### PRECAUTIONS

DO NOT USE THIS WATER HEATER IF ANY PART HAS BEEN UNDER WATER. Immediately call a qualified service technician to inspect the water heater and to replace any part of the control system and any gas control which has been under water.

IF THE UNIT IS EXPOSED TO THE FOLLOWING, DO NOT OPERATE HEATER UNTIL ALL CORRECTIVE STEPS HAVE BEEN MADE BY A QUALIFIED SERVICEMAN.

1. EXTERNAL FIRE.
2. DAMAGE.
3. FIRING WITHOUT WATER.
4. SOOTING.

Heater must be protected from freezing downdrafts during shutdown periods.

### PREPARING FOR THE INSTALLATION

1. Read the "General Safety" section, page 3 of this manual first and then the entire manual carefully. If you don't follow the safety rules, the water heater will not operate properly. It could cause DEATH, SERIOUS BODILY INJURY AND/OR PROPERTY DAMAGE.

This manual contains instructions for the installation, operation, and maintenance of the gas-fired water heater. It also contains warnings throughout the manual that you must read and be aware of. All warnings and all instructions are essential to the proper operation of the water heater and your safety. Since we cannot put everything on the first few pages, **READ THE ENTIRE MANUAL BEFORE ATTEMPTING TO INSTALL OR OPERATE THE WATER HEATER.**

2. The installation must conform with these instructions and the local code authority having jurisdiction. In the absence of local codes, installations shall comply with the National Fuel Gas Code ANSI Z223.1/NFPA 54 current addition. This publication is available from the CSA International, 8501 East Pleasant Valley Rd., Cleveland Ohio 44131, or The National Fire Protection Association, 1 Batterymarch Park, Quincy, MA 02269.

3. If after reading this manual you have any questions or do not understand any portion of the instructions, call the local gas utility or the manufacturer whose name appears on the rating plate.

4. Carefully plan the place where you are going to put the water heater. Correct combustion, vent action, and vent pipe installation are very important in preventing death from possible carbon monoxide poisoning and fires, see Figures 3 through 8A.

Examine the location to ensure the water heater complies with the "Locating the New Water Heater" section in this manual.

5. For California installation this water heater must be braced, anchored, or strapped to avoid falling or moving during an earthquake. See instructions for correct installation procedures. Instructions may be obtained from California Office of the State Architect, 400 P Street, Sacramento, CA 95814.

6. Massachusetts Code requires this water heater to be installed in accordance with Massachusetts 248-CMR 2.00: State Plumbing Code and 248-CMR 5.00.

7. Complies with SCAQMD rule #1146.2 and districts having equivalent NOx requirements.

### GROUNDING INSTRUCTIONS

This water heater must be grounded in accordance with the National Electrical Code and/or local codes. These must be followed in all cases.

This water heater must be connected to a grounded metal, permanent wiring system; or an equipment grounding conductor must be run with the circuit conductors and connected to the equipment grounding terminal or lead on the water heater, see Figure 5.

## CHEMICAL VAPOR CORROSION

### WARNING

CORROSION OF THE FLUEWAYS AND VENT SYSTEM MAY OCCUR IF AIR FOR COMBUSTION CONTAINS CERTAIN CHEMICAL VAPORS. SUCH CORROSION MAY RESULT IN FAILURE AND RISK OF ASPHYXIATION.

Spray can propellants, cleaning solvents, refrigerator and air conditioning refrigerants, swimming pool chemicals, calcium and sodium chloride (water softener salt), waxes, and process chemicals are typical compounds which are potentially corrosive. Do not store products of this sort near the heater. Also, air which is brought in contact with the heater should not contain any of these chemicals. If necessary, uncontaminated air should be obtained from remote or outside sources. The limited warranty is voided when failure of water heater is due to a corrosive atmosphere. (Refer to the limited warranty for complete terms and conditions.)

## EXTENDED NON-USE PERIODS

### WARNING

HYDROGEN GAS CAN BE PRODUCED IN A HOT WATER SYSTEM SERVED BY THIS HEATER THAT HAS NOT BEEN USED FOR A LONG PERIOD OF TIME (GENERALLY TWO WEEKS OR MORE). HYDROGEN GAS IS EXTREMELY FLAMMABLE. To reduce the risk of injury under these conditions, it is recommended that the hot water faucet be opened for several minutes at the kitchen sink before using any electrical water heater connected to the hot water system. If hydrogen is present, there will probably be an unusual sound such as air escaping through the pipe as the water begins to flow. **THERE SHOULD BE NO SMOKING OR OPEN FLAME NEAR THE FAUCET AT THE TIME IT IS OPEN.**

## INSULATION BLANKETS

Insulation blankets available to the general public for external use on gas water heaters are not required for use on this water heater. The purpose of an insulation blanket is to reduce the standby heat loss encountered with storage tank water heaters. This water heater meets or exceeds the current edition of ASHRAE/IES 90.1 standards with respect to insulation and standby loss requirement making an insulation blanket unnecessary.

### WARNING

Should you choose to apply an insulation blanket to this heater, you should follow these instructions. Failure to follow these instructions can result in fire, asphyxiation, serious personal injury or death.

- Do not apply insulation to the top of the water heater, as this will interfere with safe operation.
- Do not cover the outer door, thermostat or temperature & pressure relief valve.
- Do not allow insulation to come within 2" (5cm) of the floor to prevent blockage of combustion air flow to the burner.
- Do not cover the instruction manual. Keep it on the side of the water heater or nearby for future reference.
- Do obtain new warning and instruction labels from manufacturer for placement on the blanket directly over the existing labels.
- Do inspect the insulation blanket frequently to make certain it does not sag, thereby obstructing combustion air flow.

## HIGH ALTITUDE INSTALLATIONS

 **WARNING**

**Breathing Hazard - Carbon Monoxide Gas**



- High altitude orifice must be installed if a standard model is installed above 7,700 feet (2347m).
- Contact your local supplier.

**Breathing carbon monoxide can cause brain damage or death. Always read and understand instruction manual.**

Water heaters covered in this manual have been tested and approved for installation at elevations up to 7,700 feet (2,347 m) above sea level. For installation above 7,700 feet (2,347 m), the water heater's Btu input should be reduced at the rate of 4 percent for each 1,000 feet (305 m) above sea level which requires replacement of the burner orifice in accordance with the National Fuel Gas Code ANSI Z223.1/NFPA 54. Contact your local gas supplier for further information.

Failure to replace the standard orifice with the proper high altitude orifice when installed at elevations above 7,700 feet (2,347 m) could result in improper and inefficient operation of the water heater, producing carbon monoxide gas in excess of the safe limits. This could result in serious injury or death. Contact your local gas supplier for any specific changes that may be required in your area.

 **WARNING**

**Fire or Explosion Hazard**



Read instruction manual before installing, using or servicing water heater.

- Improper use may result in fire or explosion.
- Maintain required clearances to combustibles.



The input reduction is primarily achieved by reducing the size of the main burner orifices. To do this, the main burner orifices require replacement with orifices sized for the particular installation elevation. Correct orifice sizing and parts may be obtained from your distributor or manufacturer. When ordering, be sure to state the model number and the altitude of the location where the water heater is being installed.

Upon completion of derating of the heater, adjustment to the gas pressure regulator may be required. See CHECKING THE GAS INPUT section in this manual for inlet and manifold pressure requirements.

Also due to the input rating reduction required at high altitudes, the output rating of the water heater is also reduced and should be compensated for in the sizing of the equipment for application.



## CIRCULATING PUMP

A circulating pump is used when a system requires a circulating loop or there is a storage tank used in conjunction with the heater. Refer to the piping diagrams at rear of manual for electrical hookup information and install in accordance with the current edition of the National Electrical Code ANSI/NFPA No. 70.

Only all bronze circulating pumps are used with commercial water heaters. Although circulators are oiled and operated by the manufacturer some circulators must be oiled again before operating. Please refer to manufacturer's instructions.

# INSTALLATION INSTRUCTIONS

## REQUIRED ABILITY

INSTALLATION OR SERVICE OF THIS WATER HEATER REQUIRES ABILITY EQUIVALENT TO THAT OF A LICENSED TRADESMAN IN THE FIELD INVOLVED. PLUMBING, AIR SUPPLY, VENTING, ELECTRICAL AND GAS SUPPLY WORK ARE REQUIRED.

## LOCATING THE HEATER

### WARNING

**THERE IS A RISK IN USING FUEL BURNING APPLIANCES SUCH AS GAS WATER HEATERS IN ROOMS, GARAGES OR OTHER AREAS WHERE GASOLINE, OTHER FLAMMABLE LIQUIDS OR ENGINE DRIVEN EQUIPMENT OR VEHICLES ARE STORED, OPERATED OR REPAIRED. FLAMMABLE VAPORS ARE HEAVY AND TRAVEL ALONG THE FLOOR AND MAY BE IGNITED BY THE HEATER'S PILOT OR MAIN BURNER FLAMES CAUSING FIRE OR EXPLOSION.** SOME LOCAL CODES PERMIT OPERATION OF GAS APPLIANCES IF INSTALLED 18 INCHES (45.7 CM) OR MORE ABOVE THE FLOOR. THIS MAY REDUCE THE RISK IF LOCATION IN SUCH AN AREA CANNOT BE AVOIDED.

**DO NOT INSTALL THIS WATER HEATER DIRECTLY ON A CARPETED FLOOR. A FIRE HAZARD MAY RESULT.** Instead the water heater must be placed on a metal or wood panel extending beyond the full width and depth by at least 3 inches (7.6 cm) in any direction. If the heater is installed in a carpeted alcove or closet, the entire floor shall be covered by the panel. Also, see the drain requirements.

THE WATER SUPPLY PRESSURE SHOULD NOT EXCEED 80 PSI (551.58 kPa). IF THIS OCCURS, A PRESSURE REDUCING VALVE WITH A BYPASS SHOULD BE PLACED ON THE SUPPLY TO THE ENTIRE HOUSE IN ORDER TO MAINTAIN EQUAL HOT AND COLD WATER PRESSURES.

THIS HEATER SHALL BE LOCATED OR PROTECTED SO IT IS NOT SUBJECT TO PHYSICAL DAMAGE BY A MOVING VEHICLE.

### WARNING

**FLAMMABLE ITEMS, PRESSURIZED CONTAINERS OR ANY OTHER POTENTIAL FIRE HAZARDOUS ARTICLES MUST NEVER BE PLACED ON OR ADJACENT TO THE HEATER. OPEN CONTAINERS OF FLAMMABLE MATERIAL SHOULD NOT BE STORED OR USED IN THE SAME ROOM WITH THE HEATER.**

When installing the heater, consideration must be given to proper location. Location selected should be as close to the stack or chimney as practicable, with adequate air supply and as centralized with the piping system as possible.

**THE HEATER MUST NOT BE LOCATED IN AN AREA WHERE IT WILL BE SUBJECT TO FREEZING.**

THE HEATER SHOULD BE LOCATED IN AN AREA WHERE LEAKAGE FROM THE HEATER OR CONNECTIONS WILL NOT RESULT IN DAMAGE TO THE ADJACENT AREA OR TO LOWER FLOORS OF THE STRUCTURE.

WHEN SUCH LOCATIONS CANNOT BE AVOIDED, A SUITABLE DRAIN PAN SHOULD BE INSTALLED UNDER THE HEATER. Such pans should be fabricated with sides at least 2" (5cm) deep, with length and width at least 2" (5cm) greater than the diameter of the heater and must be piped to an adequate drain. The pan must not restrict combustion air flow.

Drain pans suitable for these heaters are available from your distributor or Water Heater Parts Fulfillment, 125 Southeast Parkway, Franklin, TN 37068.

For appliance installation locations with elevations above 7700 feet (610 meters), refer to HIGH ALTITUDE INSTALLATIONS section of this manual for input reduction procedure.

## CLEARANCES

These heaters are approved for installation on combustible flooring in a closet having a ceiling 12" (30.5cm) above top cover and with clearances to combustible construction of 6" (15.2cm) from flue or vent connector, 0" (0cm) at the sides and rear and 5" (10.2cm) to front to prevent a possible fire hazard condition. A minimum of 4" (10.2cm) shall be allowed for installation of serviceable parts.

## HARD WATER

Where hard water conditions exist, water softening or the threshold type of water treatment is recommended. This will protect the dishwashers, coffee urns, water heaters, water piping and other equipment.

See MAINTENANCE section for details of tank cleanout procedure.

## AIR REQUIREMENTS

REFER TO THE CURRENT EDITION OF THE "NATIONAL FUEL GAS CODE ANSI Z223.1/NFPA 54.

**KEEP APPLIANCE AREA CLEAR AND FREE OF COMBUSTIBLE MATERIALS, GASOLINE AND OTHER FLAMMABLES, VAPORS AND LIQUIDS.**

**DO NOT OBSTRUCT THE FLOW OF COMBUSTION OR VENTILATING AIR.**

### WARNING

**ATTIC AND/OR EXHAUST FANS OPERATING ON THE PREMISES WITH A WATER HEATER CAN RESULT IN CARBON MONOXIDE POISONING AND DEATH.**

OPERATION OF THESE FANS CAN PRODUCE A NEGATIVE DRAFT IN THE AREA OF THE WATER HEATER PREVENTING THE PRODUCTS OF COMBUSTION FROM EXHAUSTING THROUGH THE CHIMNEY OR VENT PIPE.

The venting of the water heater should be inspected by a qualified service technician at the time of installation and periodically thereafter to ensure a down-draft condition does not exist.

### WARNING

**FOR SAFE OPERATION PROVIDE ADEQUATE AIR FOR COMBUSTION AND VENTILATION. AN INSUFFICIENT SUPPLY OF AIR WILL CAUSE RECIRCULATION OF COMBUSTION PRODUCTS RESULTING IN AIR CONTAMINATION THAT MAY BE HAZARDOUS TO LIFE. SUCH A CONDITION OFTEN WILL RESULT IN A YELLOW, LUMINOUS BURNER FLAME, CAUSING CARBONING OR SOOTING OF THE COMBUSTION CHAMBER, BURNERS AND FLUE TUBES AND CREATES A RISK OF ASPHYXIATION.**

Where an exhaust fan is supplied in the same room with a heater, sufficient openings for air must be provided in the walls. **UNDERSIZED OPENINGS WILL CAUSE AIR TO BE DRAWN INTO THE ROOM THROUGH THE CHIMNEY, CAUSING POOR COMBUSTION. SOOTING MAY RESULT IN SERIOUS DAMAGE TO THE HEATER AND RISK OF FIRE OR EXPLOSION.**

DO NOT OBSTRUCT THE FLOW OF COMBUSTION AND VENTILATING AIR. ADEQUATE AIR FOR COMBUSTION AND VENTILATION MUST BE PROVIDED FOR SAFE OPERATION.

**UNCONFINED SPACE**

In buildings of conventional frame, brick, or stone construction, unconfined spaces may provide adequate air for combustion, ventilation and draft hood dilution.

If the unconfined space is within a building of tight construction (buildings using the following construction: weather stripping, heavy insulation, caulking, vapor barrier, etc.), air for combustion, ventilation and draft hood dilution must be obtained from outdoors. The installation instructions for confined spaces in tightly constructed buildings must be followed to ensure adequate air supply.

**CONFINED SPACE**

When drawing combustion and dilution air from inside a conventionally constructed building to a confined space, such a space shall be provided with two permanent openings, ONE IN OR WITHIN 12 INCHES (30.5cm) OF THE ENCLOSURE TOP AND ONE IN OR WITHIN 12 INCHES (30.5cm) OF THE ENCLOSURE BOTTOM. Each opening shall have a free area of at least one square inch per 1000 Btuh (2,225mm<sup>2</sup>/Kw) of the total input of all appliances in the enclosure, but not less than 100 square inches (645 square cm).

If the confined space is within a building of tight construction, air for combustion, ventilation, and draft hood dilution must be obtained from outdoors. When directly communicating with the outdoors or communicating with the outdoors through vertical ducts, two permanent openings, located in the above manner, shall be provided. Each opening shall have a free area of not less than one square inch per 4000 Btuh (8,900mm<sup>2</sup>/Kw) of the total input of all appliances in the enclosure. If horizontal ducts are used, each opening shall have a free area of not less than one square inch per 2000 Btuh (4,450mm<sup>2</sup>/Kw) of the total input of all appliances in the enclosure.

**VENTING**

**⚠ WARNING**

**THE INSTRUCTIONS IN THIS SECTION ON VENTING MUST BE FOLLOWED TO AVOID CHOKED COMBUSTION OR RECIRCULATION OF FLUE GASES. SUCH CONDITIONS CAUSE SOOTING OR RISKS OF FIRE AND ASPHYXIATION.**

This water heater must be protected from freezing downdrafts.

Remove all soot or other obstructions from the chimney that will retard a free draft.

Type B venting is recommended with these water heaters.

This water heater must be vented in compliance with all local codes, the current edition of the National Fuel Gas Code, ANSI Z223.1/NFPA 54, and with the Category I Venting Table.

If any part of the vent system are exposed to ambient temperatures below 35 degrees F (2 degrees C) it must be insulated to prevent condensation.

- Do not connect the heater to a common vent or chimney with solid

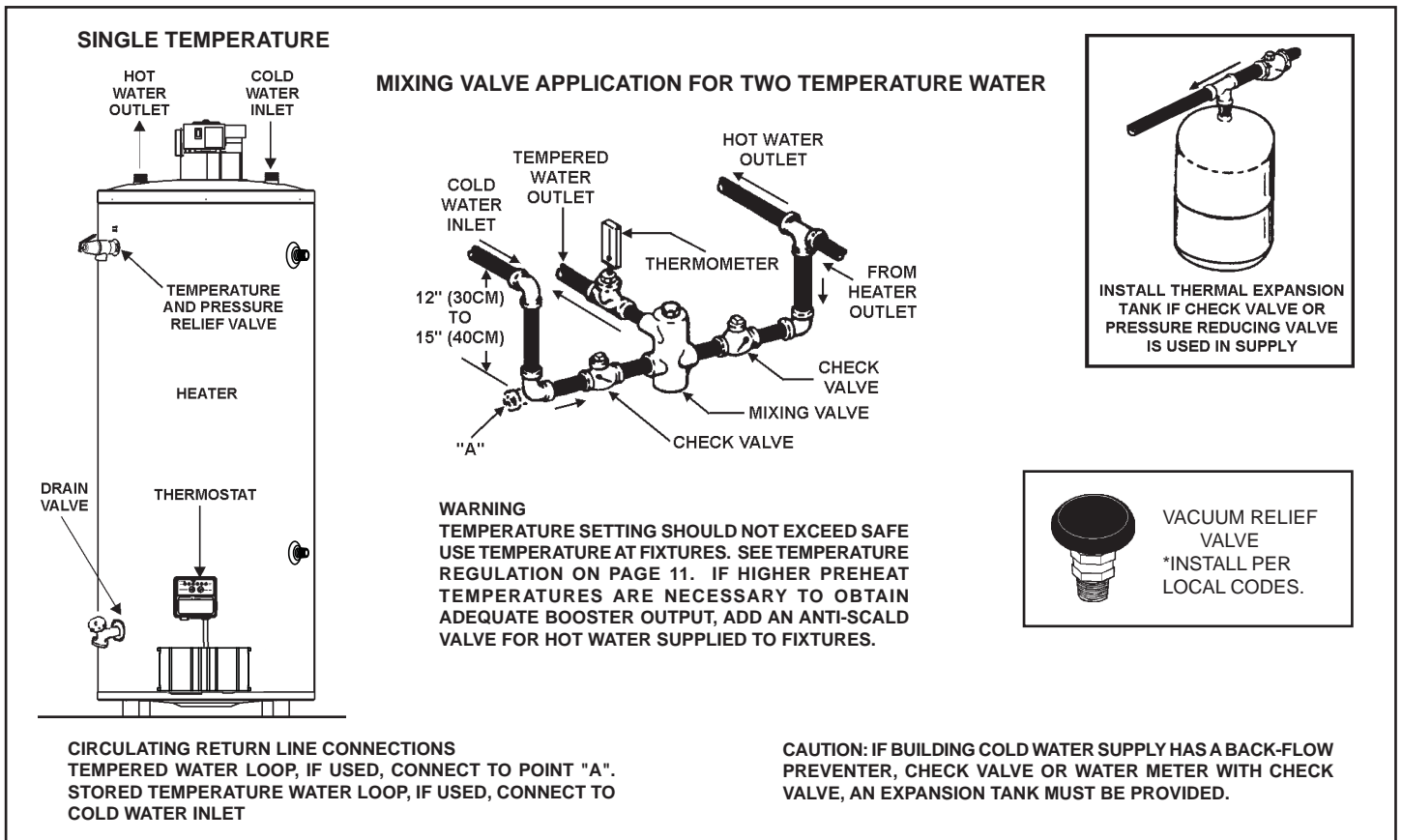
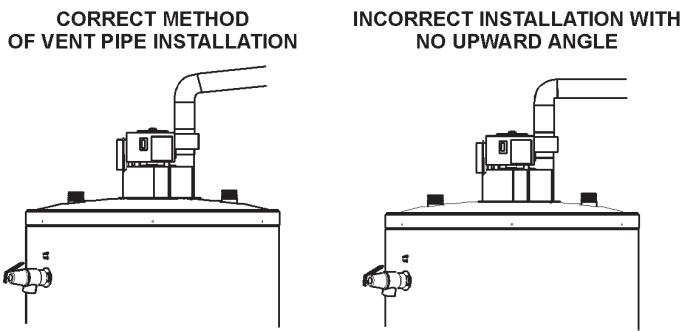

FIGURE 2.

fuel burning equipment. This practice is prohibited by many local building codes as is the practice of venting gas fired equipment to the duct work of ventilation systems.

- Where a separate vent connection is not available and the vent pipe from the heater must be connected to a common vent with an oil burning furnace, the vent pipe should enter the smaller common vent or chimney at a point above the large vent pipe.



PROVIDE MAXIMUM VERTICAL RISE OF VENT PIPE DIRECTLY ABOVE HEATER BLOWER OUTLET

FIGURE 3.

### VENT CONNECTION

Vent connections must be made to an adequate stack or chimney. Size and install proper size vent pipe. Do not reduce pipe size to less than that of the blower outlet.

Horizontal runs of vent pipe must have a minimum upward slope toward the chimney of 1/4 inch per foot (2cm per meter). Dampers or other obstructions must not be installed in between the heater and the blower. Be sure that the vent pipe does not extend beyond the inside wall of the chimney.

Where a continuous or intermittent back draft is found to exist, the cause must be determined and corrected. A special vent cap may be required. If the back draft cannot be corrected by the normal methods or if a suitable draft cannot be obtained, a blower type flue gas exhauster must be employed to assure proper venting and correct combustion.

### THERMOMETERS (Not Supplied)

Thermometers should be obtained and field installed as shown in Figure 3.

Thermometers are installed in the system as a means of detecting the temperature of the outlet water supply.

### COMBINATION WATER (POTABLE) HEATING AND SPACE HEATING

1. All piping components connected to this unit for space heating applications shall be suitable for use with potable water.
2. These water heaters cannot be used in space heating applications only.
3. Toxic chemicals, such as those used for boiler treatment, shall NEVER be introduced into this system.
4. This unit may NEVER be connected to any existing heating system or component(s) previously used with a non-potable water heating appliance.
5. When the system requires water for space heating at temperatures higher than required for domestic water purposes, a tempering valve must be installed. Please refer to installation diagram on page 6 of this manual for suggested piping arrangements.

### ⚠ CAUTION

A closed system will exist if a check valve (without bypass), pressure reducing valve (without bypass), or a water meter (without bypass) is installed in the cold water line between the water heater and street main (or well).

Excessive pressure may develop in such closed systems, causing premature tank failure or intermittent relief valve operation. This is not a warranty failure. An expansion tank or a similar device may be required in the inlet supply line between the appliance and the meter or valve to compensate for the thermal expansion of the water.

As water is heated, it expands (thermal expansion). In a closed system, the volume of water will increase. As the volume of water increases, there will be a corresponding increase in water pressure due to thermal expansion. Thermal expansion can cause premature tank failure (leakage). This type of failure is not covered under the limited warranty. Thermal expansion can also cause intermittent temperature-pressure relief valve operation: water discharged from the valve due to excessive pressure build up. The temperature-pressure relief valve is not intended for the constant relief of thermal expansion. This condition is not covered under the limited warranty.

A properly-sized thermal expansion tank should be installed on all closed systems to control the harmful effects of thermal expansion. Contact a plumbing service agency or your retail supplier regarding the installation of a thermal expansion tank.

### MIXING VALVES

	<p><b>⚠ DANGER</b></p> <p>Water temperature over 125°F (52°C) can cause severe burns instantly resulting in severe injury or death.</p>
	<p>Children, the elderly and the physically or mentally disabled are at highest risk for scald injury.</p>
	<p>Feel water before bathing or showering.</p>
	<p>Temperature limiting devices such as mixing valves must be installed when required by codes and to ensure safe temperatures at fixtures.</p>

Water heated to a temperature which will satisfy clothes washing, dish washing, and other sanitizing needs can scald and cause permanent injury upon contact. Short repeated heating cycles caused by small hot water uses can cause temperatures at the point of use to exceed the water heater's temperature setting by up to 20°F (11°C).

Some people are more likely to be permanently injured by hot water than others. These include the elderly, children, the infirm and the physically/mentally disabled. Table 1 shows the approximate time-to-burn relationship for normal adult skin. If anyone using hot water provided by the water heater being installed fits into one of these groups or if there is a local code or state law requiring a certain water temperature at the point of use, then special precautions must be taken.

In addition to using lowest possible temperature setting that satisfies demand of application a Mixing Valve should be installed at water heater (see Figure 3) or at hot water taps to further reduce system water temperature.

Mixing valves are available at plumbing supply stores. Consult a Qualified Installer or Service Agency. Follow mixing valve manufacturer's instructions for installation of the valves.



**TABLE 4. GAS SUPPLY LINE SIZES (IN INCHES)\***

Water Temperature °F	Time for 1 <sup>st</sup> Degree Burns (Less Severe Burns)	Time for Permanent Burns 2nd & 3rd Degree (Most Severe Burns)
110	(normal shower temp.)	
116	(pain threshold)	
116	35 minutes	45 minutes
122	1 minute	5 minutes
131	5 seconds	25 seconds
140	2 seconds	5 seconds
149	1 second	2 seconds
154	instantaneous	1 seconds

(U.S. Government Memorandum, C.P.S.C., Peter L. Armstrong, Sept. 15, 1978)

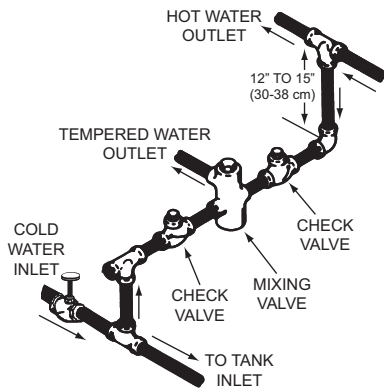

**FIGURE 4.  
SYSTEM CONNECTIONS**

The system installation must conform to these instructions and to the local code authority having jurisdiction. Good practice requires that all heavy piping be supported.

**RELIEF VALVE**

This water heater is equipped with a combination temperature-pressure relief valve that complies with the standard for relief valves for hot water supply systems Z21.22-CSA 4.4. **FOR SAFE OPERATION OF THE WATER HEATER, THE RELIEF VALVE(S) MUST NOT BE REMOVED OR PLUGGED.**

ASME ratings cover pressure relief capacities. ANSI ratings cover release rate with temperature actuation.

In addition to the water heater relief valve, each remote storage tank which may be used in conjunction with this appliance shall also be installed with a properly sized, rated and approved combination temperature (ANSI) and pressure (ASME) relief valve(s). This valve shall comply with the standard for relief valves for hot water supply systems Z21.22-CSA 4.4.

**WARNING**

**THE PURPOSE OF RELIEF VALVE IS TO AVOID EXCESSIVE PRESSURE OR TEMPERATURE INTO THE STEAM RANGE, WHICH MAY CAUSE SCALDING AT FIXTURES, TANK EXPLOSION, SYSTEM OR HEATER DAMAGE. NO VALVE IS TO BE PLACED BETWEEN THE RELIEF VALVE AND TANK.**

Your local code authority may have other specific relief valve requirements.

**A DRAIN LINE MUST BE CONNECTED TO THE RELIEF VALVE TO DIRECT DISCHARGE TO A SAFE LOCATION TO AVOID SCALDING OR WATER DAMAGE. THIS LINE MUST NOT BE REDUCED FROM THE SIZE OF THE VALVE OUTLET AND MUST NOT CONTAIN VALVES,**

**RESTRICTIONS NOR SHOULD IT BE LOCATED IN FREEZING AREAS. DO NOT THREAD OR CAP THE END OF THIS LINE. RESTRICTED OR BLOCKED DISCHARGE WILL DEFEAT THE PURPOSE OF THE VALVE AND IS UNSAFE. DISCHARGE LINE SHALL BE INSTALLED TO ALLOW COMPLETE DRAINAGE OF BOTH THE VALVE AND LINE.**

See SERVICE INFORMATION section for procedure and precautions.

The type, size and location of the relief valves must be in accordance with local codes. The location of the relief valve is shown in Figure 1. The heater has a factory installed high temperature limit switch.

**GAS PIPING**

Contact your local gas service company to ensure that adequate gas service is available and to review applicable installation codes for your area.

Size the main gas line in accordance with Table 4. The figures shown are for straight lengths of pipe at 0.5" W.C. (.125 kPa) pressure drop, which is considered normal for low pressure systems. Note: Fittings such as elbows, tees and line regulators will add to the pipe pressure drop. Also refer to the current edition of the National Fuel Gas Code.

**WARNING**

The minimum gas supply pressure for input adjustment is 6.0" W.C.(1.49 kPa) for natural gas.

**THE HEATER IS NOT INTENDED FOR OPERATION AT HIGHER THAN 14" W.C. (3.49 kPa) SUPPLY PRESSURE. EXPOSURE TO HIGHER GAS SUPPLY PRESSURE MAY CAUSE DAMAGE TO THE CONTROL WHICH COULD RESULT IN FIRE OR EXPLOSION.** If overpressure has occurred such as through improper testing of gas lines or emergency malfunction of the supply system, the control must be checked for safe operation. Make sure that the outside vents on the supply regulators and the safety vent valves are protected against blockage. These are parts of the gas supply system not the heater. Vent blockage may occur during ice storms.

**IT IS IMPORTANT TO GUARD AGAINST GAS VALVE FOULING FROM CONTAMINANTS IN THE GAS WAYS. SUCH FOULING MAY CAUSE IMPROPER OPERATION, FIRE OR EXPLOSION.**

**IF COPPER SUPPLY LINES ARE USED THEY MUST BE INTERNALLY TINNED AND CERTIFIED FOR GAS SERVICE. BEFORE ATTACHING THE GAS LINE, BE SURE THAT ALL GAS PIPE IS CLEAN ON THE INSIDE.**

**TO TRAP ANY DIRT OR FOREIGN MATERIAL IN THE GAS SUPPLY LINE, A SEDIMENT TRAP MUST BE INCORPORATED IN THE PIPING (SEE FIG. 5). THE SEDIMENT TRAP MUST BE READILY ACCESSIBLE AND NOT SUBJECT TO FREEZING CONDITIONS. INSTALL IN ACCORDANCE WITH RECOMMENDATIONS OF SERVING GAS SUPPLIERS. REFER TO THE CURRENT EDITION OF THE NATIONAL FUEL GAS CODE.**

To prevent damage, care must be taken not to apply too much torque when attaching gas supply pipe to gas valve inlet.

Apply joint compounds (pipe dope) sparingly and only to the male threads of pipe joints. Do not apply compounds to the first two threads. Use compounds resistant to the action of liquefied petroleum gases.

**TABLE 5 MAXIMUM CAPACITY OF PIPE IN CUBIC FEET PER HOUR**

LENGTH IN FEET	NORMAL IRON PIPE SIZES (INCHES) INPUT IN THOUSANDS BTU/HR								
	1/2"	3/4"	1"	1 1/4"	1 1/2"	2"	2 1/2"	3"	4"
10	175	360	680	1400	2100	3960	6300	11000	230000
20	120	250	485	950	1460	2750	4360	7700	15800
30	97	200	375	770	1180	2200	3520	6250	12800
40	82	170	320	660	990	1900	3000	5300	10900
50	73	151	285	580	900	1680	2650	4750	9700
60	66	138	260	530	810	1520	2400	4300	8800
70	61	125	240	490	750	1400	2250	3900	8100
80	57	118	220	460	690	1300	2050	3700	7500
90	53	110	205	430	650	1220	1950	3450	7200
100	50	103	195	400	620	1150	1850	3250	6700
125	44	93	175	360	550	1020	1650	2950	6000
150	40	84	160	325	500	950	1500	2650	5500
175	37	77	145	300	460	850	1370	2450	5000
200	35	72	135	280	430	800	1280	2280	4600

LENGTH IN METERS	NORMAL IRON PIPE SIZES (INCHES) INPUT IN KW								
	1/2"	3/4"	1"	1 1/4"	1 1/2"	2"	2 1/2"	3"	4"
3.0	51	105	199	410	615	1160	1845	3221	6735
6.1	35	73	142	278	428	805	1277	2255	4626
9.1	28	59	110	225	346	644	1031	1830	3748
12.2	24	50	94	193	290	556	878	1552	3192
15.2	21	44	83	170	264	492	776	1391	2840
18.3	19	40	76	155	237	445	703	1259	2577
21.3	18	37	70	143	220	410	659	1142	2372
24.4	17	35	64	165	202	381	600	1083	2196
27.4	16	32	60	126	190	357	571	1010	2108
30.5	15	30	57	117	182	337	542	952	1962
38.1	13	27	51	105	161	299	483	864	1757
45.7	12	25	47	95	146	278	439	776	1610
53.3	11	23	42	88	135	249	401	717	1464
61.0	10	21	40	82	126	234	375	688	1347

**BEFORE PLACING THE HEATER IN OPERATION, CHECK FOR GAS LEAKAGE.** Use soap and water solution or other material acceptable for the purpose in locating the leaks. **DO NOT USE MATCHES, CANDLES, FLAME OR OTHER SOURCES OF IGNITION FOR THIS PURPOSE.**  
**FIGURE 5. GAS PIPING AND SEDIMENT TRAP INSTALLATION**

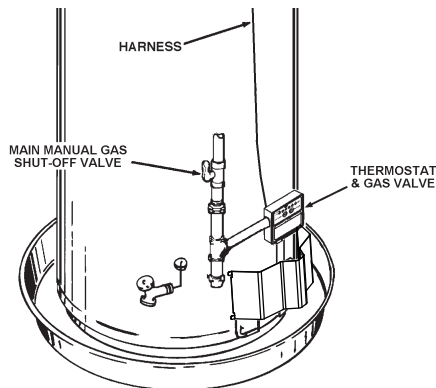

**DISCONNECT THE HEATER AND ITS MANUAL GAS SHUTOFF VALVE FROM THE GAS SUPPLY PIPING SYSTEM DURING ANY SUPPLY PRESSURE TESTING EXCEEDING 1/2 PSIG (3.45 kPa). GAS SUPPLY LINE MUST BE CAPPED WHEN DISCONNECTED FROM THE HEATER FOR TEST PRESSURES OF 1/2 PSIG (3.45 kPa) OR LESS. THE WATER HEATER NEED NOT BE DISCONNECTED, BUT MUST BE ISOLATED FROM THE SUPPLY PRESSURE TEST BY CLOSING THE MANUAL GAS SHUTOFF VALVE.**

**PURGING**

Gas line purging is required with new piping or systems in which air has entered.

**CAUTION**

**PURGING SHOULD BE PERFORMED BY PERSONS EXPERIENCED IN THIS TYPE GAS SERVICE. TO AVOID RISK OF FIRE OR EXPLOSION, PURGE DISCHARGE MUST NOT ENTER CONFINED AREAS OR SPACES WHERE IGNITION CAN OCCUR. THE AREA MUST BE WELL VENTILATED AND ALL SOURCES OF IGNITION MUST BE INACTIVATED OR REMOVED.**

**GAS METER SIZE — NATURAL GASES ONLY**

Be sure the gas meter has sufficient capacity to supply the full rated gas input of the water heater as well as the requirements of all other gas fired equipment supplied by the meter. If gas meter is too small, ask the gas company to install a larger meter having adequate capacity.

**GAS PRESSURE REGULATOR**

The gas pressure regulator is built into the gas valve and is equipped to operate on the gas specified on model and rating plate. The regulator is factory adjusted to deliver gas to burner at correct water column pressure allowing for a nominal pressure drop through the controls.

The minimum gas supply pressure for input adjustment must not be less than 6" w.c. (1.49 kPa) for natural gas.

Do not subject the combination gas valve to inlet gas pressures of more than 14.0" w.c. (3.48 kPa) - natural gas. A service regulator is necessary if higher gas pressures are encountered.

Gas pressure specified in Table 5, refer to flow pressure taken at pressure tap of automatic gas valve while heater is operating.

TABLE 6. GAS PRESSURE

Type of Gas	Input	Manifold Pressure
Natural	75,100 Btu/hr 22 KW/hr	4.0 in. W.C. 1.12 kPa

**OPERATION**

It is recommended that a qualified person perform the initial firing of the heater. At this time the user should not hesitate to ask the individual any questions which he may have in regard to the operation and maintenance of the unit.

**TO OPERATE THE HEATER**

1. Close the heater drain valve (Figure 1) by turning handle clockwise 
2. Open a nearby hot water faucet to permit the air in the system to escape.
3. Fully open the cold water inlet pipe valve (Figure 1) allowing the heater and piping to be filled.
4. Close the hot water faucet as water starts to flow.
5. The heater is ready to be operated.

**WARNING**

**DO NOT ATTEMPT TO OPERATE WATER HEATER WITH COLD WATER INLET VALVE CLOSED.**

**NEVER OPERATE THE HEATER WITHOUT FIRST BEING CERTAIN IT IS FILLED WITH WATER AND A TEMPERATURE AND PRESSURE RELIEF VALVE IS INSTALLED IN THE RELIEF VALVE OPENING OF THE HEATER.**

## HEATER WIRING

All electrical work must be installed in the United States in accordance with the current edition of the National Electrical Code ANSI/NFPA No. 70, in Canada, must conform to all local code authority having jurisdiction. AN ELECTRICAL GROUND IS REQUIRED TO REDUCE RISK OF ELECTRICAL SHOCK OR POSSIBLE ELECTROCUTION.

If any of the original wire as supplied with the appliance must be replaced, use only type 105°C thermoplastic or equivalent, 250°C type F must be used for the flame sensor leads and the spark ignition cable must be high voltage 250°C.



LABEL ALL WIRES PRIOR TO DISCONNECTION WHEN SERVICING CONTROLS. WIRING ERRORS CAN CAUSE IMPROPER AND DANGEROUS OPERATION. VERIFY PROPER OPERATION AFTER SERVICING.

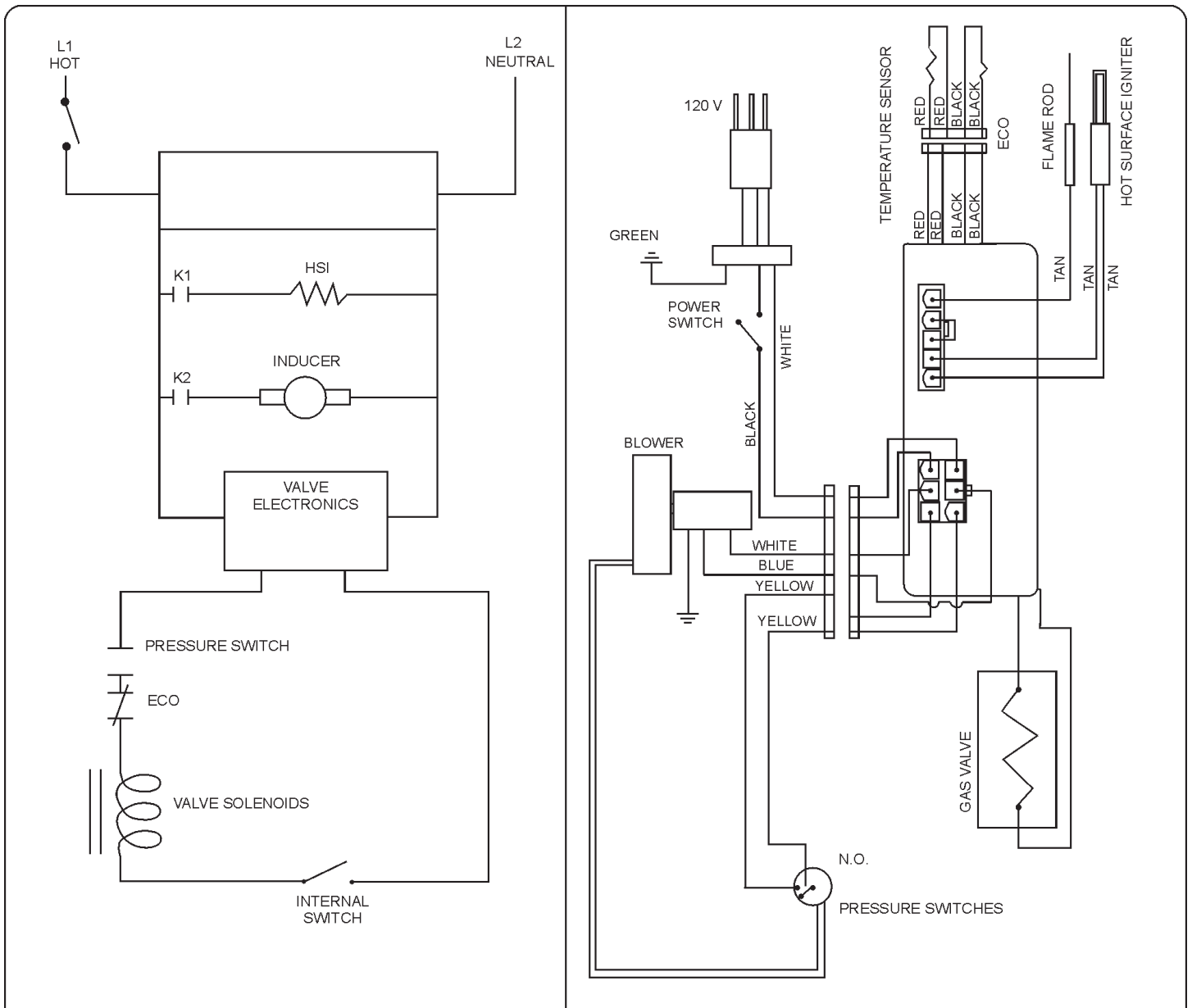

### WARNING

DISCONNECT FROM ELECTRICAL SUPPLY BEFORE SERVICING UNIT. REPLACE ALL DOORS AND PANELS BEFORE OPERATING HEATER.

IF ANY OF THE ORIGINAL WIRES SUPPLIED WITH THE APPLIANCE MUST BE REPLACED, IT MUST BE REPLACED WITH APPLIANCE WIRE MATERIAL WITH MINIMUM TEMPERATURE RATING OF 221°F(105°C) AND A MINIMUM SIZE OF NO. 18 AWG.

**FIGURE 6. WIRING DIAGRAM AND SCHEMATIC**

## FOR YOUR SAFETY READ BEFORE OPERATING



**WARNING:** If you do not follow these instructions exactly, a fire or explosion may result causing property damage, personal injury or loss of life.









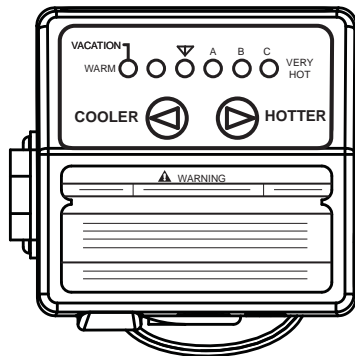



### BEFORE OPERATING: ENTIRE SYSTEM MUST BE FILLED WITH WATER AND AIR PURGED FROM ALL LINES.

- A. This appliance does not have a pilot. It is equipped with an ignition device which automatically lights the burner. Do not try to light the burner by hand.
- B. **BEFORE OPERATING** smell all around the appliance area for gas. Be sure to smell next to the floor because some gas is heavier than air and will settle on the floor.
- WHAT TO DO IF YOU SMELL GAS:**
- Do not try to light any appliance.
  - Do not touch any electric switch; do not use any phone in your building.
  - Immediately call your gas supplier from a neighbor's phone. Follow the gas supplier's instructions.
- C. Use only your hand to push in the control buttons. Never use tools. If the control buttons will not push in, don't try to repair them, call a qualified service technician. Force or attempted repair may result in a fire or explosion.
- D. Do not use this appliance if any part has been under water. Immediately call a qualified service technician to inspect the appliance and to replace any part of the control system and any gas control which has been under water.

## OPERATING INSTRUCTIONS



1.  STOP! Read the safety information above on this label.
2. Set the thermostat to the lowest setting by first pressing the COOLER  and HOTTER  buttons together and holding for 1 second. Then press the COOLER  button until the WARM indicator light appears.
3. Turn the "ON/OFF" switch on the blower control to the "OFF" position.
4. This appliance is equipped with a device which automatically lights the burner.  
**DO NOT TRY TO LIGHT THE BURNER BY HAND.**
5. Wait five (5) minutes  to clear out any gas. If you then smell gas, STOP! Follow "B" in the safety information  above on this label. If you don't smell gas, go to next step.
6. Turn on all electrical power to the appliance.
7. Set thermostat to desired setting by first pressing the COOLER  and HOTTER  buttons together and holding for 1 second. Then press the HOTTER  button.
8. If the appliance will not operate, follow the instructions "TO TURN OFF GAS TO APPLIANCE" and call your technician or gas supplier.
9. WATER TEMPERATURE ADJUSTMENT  
 is approximately 120°F (49°C).



**CAUTION: Hotter water increases the risk of scald injury. Consult the instruction manual before changing temperatures.**



**WARNING: TURN OFF ALL ELECTRIC POWER BEFORE SERVICING**

## TO TURN OFF GAS TO APPLIANCE

- A. Set thermostat to the lowest setting.
- B. Turn off all the electric power to the appliance if service is to be performed.

## TEMPERATURE REGULATION



**▲ DANGER**

THIS WATER HEATER IS EQUIPPED WITH AN ADJUSTABLE THERMOSTAT TO CONTROL WATER TEMPERATURE. HOT WATER TEMPERATURES REQUIRED FOR AUTOMATIC DISHWASHING AND LAUNDRY USE CAN CAUSE PAINFUL SCALDING WITH POSSIBLE SERIOUS AND PERMANENT INJURY. THE TEMPERATURE AT WHICH INJURY OCCURS VARIES WITH THE PERSON'S AGE AND THE TIME OF THE EXPOSURE. THE SLOWER RESPONSE TIME OF CHILDREN, AGED OR DISABLED PERSONS INCREASES THE HAZARDS TO THEM. NEVER ALLOW SMALL CHILDREN TO USE A HOT WATER TAP, OR TO DRAW THEIR OWN BATH WATER. NEVER LEAVE A CHILD OR DISABLED PERSON UNATTENDED IN A BATHTUB OR SHOWER.

THE WATER HEATER SHOULD BE LOCATED IN AN AREA WHERE THE GENERAL PUBLIC DOES NOT HAVE ACCESS. IF A SUITABLE AREA IS NOT AVAILABLE, A COVER SHOULD BE INSTALLED OVER THE THERMOSTAT TO PREVENT TAMPERING. Suitable covers are available through Water Heater Parts Fulfillment, 125 Southeast Parkway, Franklin, TN 37068.

Water Temperature °F (°C)	Time for 1st Degree Burn (Less Severe Burns)	Time for Permanent Burns 2nd & 3rd Degree (Most Severe Burns)
110 (43.3)	(normal shower temp.)	
116 (46.6)	(pain threshold)	
116 (46.6)	35 minutes	45 minutes
122 (50)	1 minute	5 minutes
131 (55)	5 seconds	25 seconds
140 (60)	2 seconds	5 seconds
149 (65)	1 second	2 seconds
154 (67.7)	instantaneous	1 second

(U.S. Government Memorandum, C.P.S.C., Peter L. Armstrong, Sept. 15, 1978)

It is recommended that lower water temperatures be used to avoid the risk of scalding. It is further recommended, in all cases, that the water temperature setting be set for the lowest temperature that satisfies your hot water needs. This will also provide the most energy efficient operation of the water heater. The water temperature adjustment was factory set at the lowest temperature. Pressing the "COOLER" button decreases temperature and pressing the "HOTTER" button increases the temperature.

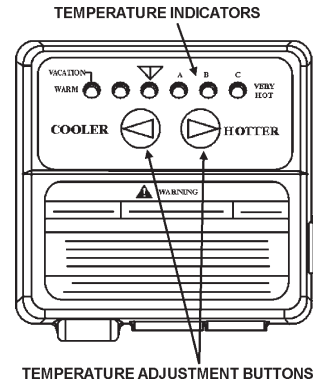

Temperature Setting	Display ▼ A B C
C-Flashing = approx. 160°F (71°C)	○○○○○●
C = approx. 150°F (66°C)	○○○○○●
B = approx. 140°F (60°C)	○○○○●○
A = approx. 130°F (54°C)	○○○●○○
▼ = approx. 120°F (49°C)	○○●○○○
WARM = approx. 80°F (27°C)	●○○○○○

FIGURE 7.

SETTING THE WATER HEATER TEMPERATURE AT 120°F (49°C) (APPROX. "▼" MARK ON FACE OF THE TEMPERATURE ADJUSTING DIAL) WILL REDUCE THE RISK OF SCALDS. Some States or Provinces require settings at specific lower temperatures.

Figure 6 shows the approximate water temperatures produced at various thermostat settings. Short repeated heating cycles caused by small hot water uses can cause temperatures at the point of use to exceed the thermostat setting by up to 20°F (11°C). If you experience this type of use you should consider using lower temperature settings to reduce scald hazards.

Valves for reducing point of use temperature by mixing cold and hot water are available. Also available are inexpensive devices that attach to faucets to limit hot water temperatures. Contact a licensed plumber or the local plumbing authority.

To avoid any unintentional changes in water temperature settings, the control has a tamper resistant feature for changing the temperature setting. To change the temperature setting follow these instructions:

- "Wake Up" the temperature indicators by holding down both the "COOLER" and "HOTTER" temperature adjustment buttons at the same time for one second (see Figure 6). One or two of the temperature indicators will light up. These indicators will only remain on for 30 seconds if no further buttons are pressed. After 30 seconds the control will go back to "Sleep" mode.
- Release both of the temperature adjustment buttons.
  - To decrease the temperature press and release the "COOLER" button until desired setting is reached.
  - To increase the temperature press and release the "HOTTER" button until the desired setting is reached.

NOTE: Holding down the button will not continue to lower or raise the temperature setting. The button must be pressed and released for each temperature change desired.

SHOULD OVERHEATING OCCUR OR THE GAS SUPPLY FAIL TO SHUT OFF, TURN OFF THE MAIN MANUAL GAS SHUTOFF VALVE TO THE APPLIANCE. SEE FIGURE 1 (G).



## CHECKING VENTING

The following steps shall be followed with each appliance connected to the venting system placed in operation, while any other appliances connected to the venting system are not in operation.

1. Seal any unused openings in the venting system.
2. Inspect the venting system for proper size and horizontal pitch, as required in the National Fuel Gas Code, ANSI Z223.1/NFPA 54 Installation codes and these instructions. Determine that there is no blockage or restriction, leakage, corrosion and other deficiencies which could cause an unsafe condition.
3. So far as is practical, close all building doors and windows and all doors between the space in which the water heater(s) connected to the venting system are located and other spaces of the building. Turn on all appliances not connected to the venting system. Turn on all exhaust fans, such as range hoods and bathroom exhausts, so they shall operate at maximum speed. Close fireplace dampers.
4. Follow the lighting instruction. Place the water heater being inspected in operation. Adjust thermostat so appliance shall operate continuously.
5. Test for vent system leakage after 5 minutes of main burner operation.
6. After it has been determined that each appliance connected to the venting system properly vents when tested as outlined above, return doors, windows, exhaust fans, fireplace dampers and any other gas burning appliance to their previous conditions of use.
7. If improper venting is observed during any of the above tests, the venting system must be corrected.

### **⚠ WARNING**

**FAILURE TO CORRECT BACK DRAFTS MAY CAUSE AIR CONTAMINATION AND UNSAFE CONDITIONS.**

## HIGH TEMPERATURE LIMIT SWITCH (ECO)

The water heater is equipped with a manual reset type high limit (Energy Cutoff) sensor. The high limit switch interrupts the main burner gas flow should the water temperature reach 195°F (90°C). The high limit switch must be manually reset by turning the power to the water heater off for 5 seconds then back on and cannot be reset until the water temperature drops below 120°F (49°C). It is important that a serviceman be called to determine the reason for limit operation and thus avoid repeated thermostat resetting.

### **⚠ WARNING**

**THE ON/OFF SWITCH MUST HAVE BEEN IN THE OFF POSITION FOR AT LEAST 5 MINUTES.** This waiting period is an important safety step. Its purpose is to permit gas that may have accumulated in the combustion chamber to clear. **IF YOU DETECT GAS ODOR AT THE END OF THIS PERIOD DO NOT PROCEED WITH LIGHTING. RECOGNIZE THAT GAS ODOR, EVEN IF IT SEEMS WEAK, MAY INDICATE PRESENCE OF ACCUMULATED GAS SOMEPLACE IN THE AREA WITH RISK OF FIRE OR EXPLOSION. SEE THE FRONT PAGE FOR STEPS TO BE TAKEN.**

**SHOULD OVERHEATING OCCUR OR THE GAS SUPPLY FAIL TO SHUT OFF, TURN OFF THE MANUAL GAS CONTROL VALVE TO THE APPLIANCE.**

## SERVICE INFORMATION

The installer may be able to observe and correct certain problems which may arise when the unit is put into operation. HOWEVER, it is recommended that only qualified servicemen, using appropriate test equipment, be allowed to service the heater.

**FOR YOUR SAFETY AND SATISFACTORY OPERATION, IT IS RECOMMENDED THAT THIS HEATER BE CHECKED ONCE A YEAR BY A COMPETENT SERVICE PERSON.**

**USERS OF THIS APPLIANCE SHOULD BE AWARE THAT GAS COMPONENTS WEAR OUT OVER A PERIOD OF TIME. THE GAS CARRYING COMPONENTS OF THIS APPLIANCE SHOULD BE INSPECTED FOR PROPER OPERATION PERIODICALLY BY A QUALIFIED SERVICE TECHNICIAN.**

## MAIN BURNER AND IGNITER

Check main burner (figure 7) at least every 6 months for proper flame characteristics. The main burner should display the following characteristics:

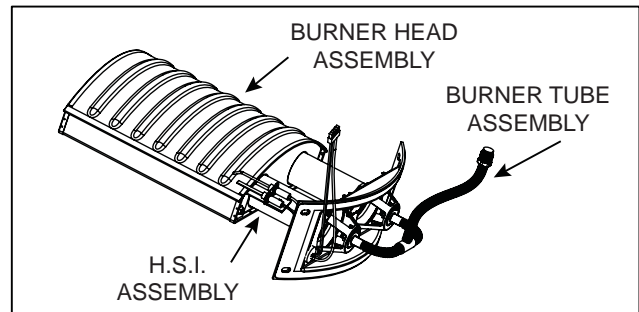

**FIGURE 8. MAIN BURNER AND IGNITER ASSEMBLY**

1. Provide complete combustion of gas.
2. Cause rapid ignition and carryover of flame across entire burner.
3. Give reasonably quiet operation during ignition, burning and extinction.
4. Cause no excessive lifting of flames from burner ports.

If preceding burner characteristics are not evident, check for accumulation of lint or other foreign material that restricts or blocks the air openings to the heater or burner.

### **⚠ WARNING**

**SOOT BUILD-UP INDICATES A PROBLEM THAT REQUIRES CORRECTION BEFORE FURTHER USE. CONSULT WITH A QUALIFIED SERVICE TECHNICIAN.**

Should the main burner or burner air openings require cleaning, remove the burner and clean with a soft brush. Clean main burner orifice with a suitable soft material.

**CHECK FOR GOOD FLOW OF COMBUSTION AND VENTILATING AIR TO THE UNIT. MAINTAIN A CLEAR OPEN AREA AROUND THE HEATER AT ALL TIMES. DO NOT STORE COMBUSTIBLES OR FLAMMABLE LIQUIDS NEAR OR AROUND AN APPLIANCE.**

## CHECKING GAS INPUT

For appliance installation locations with elevation above 2000 ft.(610m) refer to HIGH ALTITUDE INSTALLATIONS section of this manual for input reduction procedure.

With this heater in operation, determine whether it is receiving the full rated input of gas. This may be done by timing the gas meter and measuring gas pressure with a gauge or manometer. When the heater is operating at full capacity (full gas input) it should consume approximately 1 cubic foot of gas in the time shown in table 6.

**TABLE 7  
INPUT CHECK TIME REQUIRED TO CONSUME 1 CU. FT. OF GAS**

Type of Gas	BTU Per Cu. Ft.	Time Required To Consume 1 Cu. Ft. of Gas
Natural	1050	50.3 Seconds

Use this formula to “clock” the meter. Be sure that other gas consuming appliances are not operating during this interval.

$$3,600 \times \frac{H}{T} = \text{Btu/h}$$

T = Time in seconds needed to burn one cubic foot of gas.

H = Heating value of gas in Btu's per cubic foot of gas.

Btuh = Actual heater input rate.

Example:

T = 47.2 seconds/ft<sup>3</sup>

H = 1,050 Btu/ft<sup>3</sup> (natural gas)

Btuh = ?

$$3,600 \times \frac{1,050}{47.2} = 75,100 \text{ Btu/h (22Kw)}$$

50.3

Compare the actual input rate to that given on the heater's rating plate. In the example, the full input rate should be 75,100 Btu/h (22 Kw) for natural gas.

## VENT SYSTEM

Examine the venting system every 6 months for obstructions and/or deterioration of vent piping.

### BLOWER MAINTENANCE

For safety and satisfactory operation it is recommended that the blower be checked once a year by a competent service person.

1. MOTOR - The motor is factory oiled and sealed and requires no further maintenance.
2. WHEEL - Wheel must be clean of soot, ash or any other coating which inhibits either rotation or air flow. Remove all foreign material from vent system.
3. The pressure switch is inside the blower control box and is connected to the blower housing with a tube. This tubing should be soft and pliable and show no sign of deterioration.

## RELIEF VALVE

At least once a year the temperature and pressure relief valve should be checked to ensure that it is in operating condition. (During manual operation of this valve, avoid any contact with hot water and take preventive steps for water damage). Lift the lever at the top of the valve several times until the valve seats properly and operates freely.

### WARNING

THE WATER PASSING OUT OF THE VALVE DURING THIS CHECKING OPERATION MAY BE EXTREMELY HOT. AVOID CONTACT AND DISCHARGE SAFELY TO PREVENT WATER DAMAGE.

If the temperature and pressure relief valve on the heater discharges periodically or continuously, a problem exists. This may be due to unusually high water temperatures or pressures in the system, or to a faulty relief valve. Contact your dealer or a qualified service technician to find the cause of the problem and to correct it. This may also be due to thermal expansion in a closed water supply system. Contact the water supplier or local plumbing inspector on how to correct this situation. **DO NOT PLUG THE TEMPERATURE AND PRESSURE RELIEF VALVE.**

### WARNING

SHOULD OVERHEATING OCCUR OR THE GAS SUPPLY FAIL TO SHUT OFF, TURN OFF THE MANUAL GAS CONTROL VALVE TO THE APPLIANCE.

## HOT WATER ODOR

On occasion, hot water may develop a strong odor. If this occurs drain the heater completely, flush thoroughly, and refill. If the problem persists, chlorination of the heater and replacement of the factory installed magnesium anode with aluminum anode may correct the condition.

Occasionally water softener companies recommend removal of heater anodes for odor reasons.

- To check UN•LIME for continued use or reuse, place some lime scale or white chalk into a glass with a small amount of solution. If the material is vigorously dissolved by the solution, the UN•LIME can be reused. If not, the UN•LIME has been weakened and should be replaced.
8. When deliming has been completed, the heater should be flushed for 3 to 5 minutes with fresh water.
    - Remove the deliming equipment, install the drain valve, open the cold water inlet line and allow water to flow through heater and out drain valve. Don't forget to plug vent and cap opening in Flo-Jug.
  9. When flushing is completed:
    - Fill heater being certain to expel air from tank through a nearby hot water faucet or, if removed, the relief valve opening.
    - The heater relief valve can be washed in UN•LIME if it is limed.
    - Replace relief valve if removed for deliming.
    - Restore gas, oil or electrical supply to heater.
    - Check for water leakage.
  10. Flo-Jug cleanup:
    - Allow scale to separate from UN•LIME and settle on bottom of Flo-Jug.
    - Pour off UN•LIME into plastic container and check for reuse.
    - Rinse sediment from Flo-Jug.

## DRAINING AND FLUSHING

It is recommended that the tank be drained and flushed every 6 months to remove sediment which may build up during operation. The water heater should be drained if being shut down during freezing temperatures. To drain the tank, perform the following steps:

1. Turn off the gas to the water heater at the manual gas shut off valve.
2. Open a nearby hot water faucet until the water is no longer hot.
3. Close the cold water inlet valve.
4. Connect a hose to the drain valve and terminate it to an adequate drain or external to the building.
5. Open the water heater drain valve and allow all of the water to drain from the tank. Flush the tank with water as needed to remove sediment.
6. Close the drain valve, refill the tank, and restart the heater as directed in this manual.

If the water heater heater is going to be shut down for an extended period, the drain valve should be left open.

**IMPORTANT:** ccondensation may occur when refilling the tank and should not be confused with a tank leak.

# CHECKLIST

Before contacting your dealer, check the water heater to see if the apparent malfunction is caused by some external fault. Consulting this checklist may eliminate the need for a repair call and restore hot water service.

## NOT ENOUGH OR NO HOT WATER

1. Look for leaking or open hot water faucets. Check for excessive usage.
2. Your gas company can check the gas input to the heater to see that it is correct. An underfired heater will not produce hot water at its normal recovery rate.
3. If the heater was installed when incoming water temperatures were warm, colder incoming temperatures will create the effect of less hot water.
4. The thermostat water temperature adjusting dial may be set too low.
5. If you cannot determine the cause of the problems, contact your dealer.

## WATER TEMPERATURE IS TOO HOT

1. The thermostat water temperature adjusting dial may be set too high.
2. If lowering control setting does not reduce the water temperature contact your dealer.

## GAS SMELL AT THE HEATER

1. Close the main shutoff valve in the gas supply pipe near the heater, see Figure 5 on page 9.
2. Call your gas company.

## WATER LEAKAGE IS SUSPECTED

1. Check to see if the heater drain valve is tightly closed.
2. The apparent leakage might be condensation. In warm or humid locations, condensation can accumulate and run from within the heater or its piping.
  - When a water heater is first installed and filled, the bottom of the tank might condense water. The water accumulation, if excessive, can drip into the floor shield. Also, during normal operation there may be occasions when large quantities of water are drawn, chilling the tank bottom. This too can result in condensation.
  - Condensation, appearing in the vent pipe (water dripping from draft diverter) during heater operation is evidence of poor vent action. Possible causes are too long a vent pipe or improper chimney operation.
3. If the leakage is from the temperature and pressure relief valve or its discharge pipe, it may represent a normal condition. However, see RELIEF VALVE section on page 7. DO NOT PLUG THE TEMPERATURE AND PRESSURE RELIEF VALVE. Also, the leakage could be due to unusually high water pressures or temperatures in the system, or to a faulty relief valve. Your dealer or a qualified service technician should be called to determine the cause of the problem and to correct it.
4. If you cannot identify or correct the source of water leakage:
  - Close the main shutoff valve in the gas supply pipe at the heater. See Figure 5, page 9.
  - Close the valve which feeds water to the cold water inlet at the top of the heater.
  - Contact your dealer.

## WATER HEATER MAKES SOUNDS

1. Occasional excessive condensation, as explained under LEAKAGE, can cause a sizzling sound as the moisture is vaporized by the gas flame. This is a normal sound and may be disregarded.
2. Sediment and water scale accumulations may cause rumbling noises. See MAINTENANCE or contact your dealer for details of flushing the heater.
3. If you cannot identify or remedy the condition, contact your dealer.

## CONDENSATION

Water vapor can condense on the cooler surfaces of the tank forming droplets, these drip into the fire or run out on the floor. This is common at the time of startup after installation, during periods of time when incoming water is very cold, or the heater may be undersized for the requirements.

Droplets from the bottom of the flue may be due to corrosive combustion products or improper vent. Check with your dealer for more information.

## ANODE ROD INSPECTION

Each water heater contains at least one anode rod, which will slowly deplete (due to electrolysis) prolonging the life of the water heater by protecting the glass-lined tank from corrosion. Adverse water quality, hotter water temperatures, high hot water useage, and water softening methods can increase the rate of anode rod depletion. Once the anode rod is depleted, the tank will start to corrode, eventually developing a leak.

Certain water conditions will cause a reaction between the anode rod and the water. The most common complaint associated with the anode rod is a "rotten egg smell" produced from the presence of hydrogen sulfide gas dissolved in the water. IMPORTANT: Do not remove this rod permanently as it will void any warranties. The parts list includes a special anode rod that can be ordered if water odor or discoloration occurs. NOTE: This rod may reduce but not eliminate water odor problems.

Artificially softened water is exceedingly corrosive because the process substitutes sodium ions for magnesium and calcium ions. The use of a water softener may decrease the life of the water heater tank.

The anode rod should be inspected after a maximum of three years and annually thereafter until the condition of the anode rod dictates its replacement. NOTE: Artificially softened water requires the anode rod to be inspected annually.

The following are typical (but not all) signs of a depleted anode rod:

- \* The majority of the rods diameter is less than 3/8"
- \* Significant sections of the support wire (approx. 1/3 or more of the anode rods length) are visible.

If the anode rod shows signs of either or both it should be replaced. NOTE: Whether re-installing or replacing the anode rod, check for any leaks immediately, correct if found.

In replacing the anode:

1. Turn off gas supply to the water heater.
2. Shut off the water supply and open a nearby hot water faucet to depressurize the water tank.
3. Drain approximately 5 gallons of water from the tank (Refer to "Draining and Flushing" for proper procedures). Close drain valve.
4. Remove old anode rod.
5. Use Teflon® tape or approved pipe sealant on threads and install new anode rod.
6. Turn on water supply and open nearby hot water faucet to purge air from water system. Check for any leaks and immediately correct any if found.

Restart the water heater as directed under "Operating Your Water Heater." See the repair parts illustration for anode rod location.

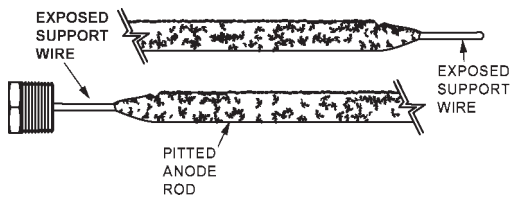

Figure 9

## SERVICE AND REPAIR

The water heater requires no special care other than the normal maintenance as noted above. If you are having a problem with your water heater, before calling for service please refer to the following TROUBLESHOOTING sections. If service becomes necessary, contact your dealer, installer or an authorized service agent. Do not attempt to repair the water heater yourself. Any work performed by unauthorized personnel may void the warranty.

# TROUBLESHOOTING

Water heaters may exhibit problems that are unrelated to a malfunction of the water heater itself. The following information and tables may serve to answer your question about a problem that you are having without having to call a service agent.

For your safety, water heater service should be performed only by a qualified service technician. Read the GENERAL SAFETY INFORMATION section first.

## WATER HEATING CYCLE

(GAS AND ELECTRIC POWER ARE ON, "OFF/ON" SWITCH IS ON)

- 1) CALLS FOR HEAT
  - A) THERMOSTAT SENSES NEED FOR HEATING WATER
  - B) CONTACTS CLOSE IN THERMOSTAT, POWER (115 VAC) FLOWS TO BLOWER MOTOR
- 2) BLOWER MOTOR ROTATES BLOWER WHEEL
  - A) BLOWER WHEEL SPEED INCREASES
  - B) WHEEL SPEED INCREASES, AIR PRESSURE SWITCH CONTACTS CLOSE
- 3) 120 VAC FLOWS TO HOT SURFACE IGNITER

**NOTE:** THE CONTROL MODULE ON THIS UNIT WILL TRY A MAXIMUM OF THREE TIMES TO LIGHT THE UNIT. CYCLE CAN BE RESTARTED AT ANY TIME BY TURNING OFF SWITCH AND THEN TURNING BACK ON. IF UNIT HAS GONE THROUGH THREE CYCLES AND DID NOT LIGHT, THEN REPAIRMAN SHOULD BE CALLED TO CHECK OPERATION OF HEATER.
- 4) MAIN BURNER IGNITES
  - A) GAS FLOWS TO MAIN BURNER PORTS AND IS IGNITED
- 5) GAS VALVE SENSES BURNER FLAME
- 6) BURNER HEATS WATER
  - A) BURNER HEATS WATER TO THERMOSTAT SETTING
  - B) CONTACTS IN THERMOSTAT OPEN,
  - C) CYCLE IS COMPLETED

## TROUBLESHOOTING

For your safety, water heater service should be performed only by a qualified service technician.  
Read the GENERAL SAFETY INFORMATION section first.







PROBLEM	POSSIBLE MALFUNCTION	SERVICE TO BE PERFORMED
<b>NOT ENOUGH OR NO HOT WATER</b>	<b>1) Blower will not run.</b>	
	A) "ON/OFF" control switch turned off.	Turn switch to the on position.
	B) Blower unplugged.	Plug blower back into 115 vac. outlet.
	C) No power at outlet.	Repair service to outlet.
	D) "ON/OFF" switch defective.	Replace switch.
	E) Control harness defective.	Replace control harness.
	F) Blower motor defective.	Replace blower and motor.
	<b>2) Blower running, burner not on</b>	Replace switch.
	A) Fan not running fast enough to close air switch contacts.	Check for low voltage, less than 102 vac., have service checked and repaired.
	B) Air pressure switch defective.	Replace switch.
	C) Gas valve defective.	Replace gas control valve/thermostat.
	D) Control harness defective.	Replace harness.
	E) Igniter defective.	Replace ignitor.
	F) Unit has completed three trials to light and fail.	Reset cycle by turning switch off and then back on. If unit does not light in three trials, contact a qualified person for service.
	<b>3) Thermostat problems</b>	
	A) Thermostat set too low.	Set temperature control higher.
	B) Thermostat or ECO defective.	Replace thermostat.
	C) High limit control circuit open.	Replace high limit control.
	<b>4) Others</b>	
	A) Heater undersized.	Reduce hot water usage.
B) Low gas pressure.	Contact a qualified person for service.	
C) Incoming water is unusually cold.	Allow more time for heater to re-heat.	
D) Leaking hot water pipes or fixtures.	Have plumber check and repair leaks.	
<b>CONDENSATION</b>	A) Water on the floor under heater.	See "Condensation"
<b>WATER LEAKS</b>	Improperly sealed, hot or cold supply connections, relief valve, drain valve or thermostat threads.	Turn off heater & water, repair unit.
	Leakage from other appliances or water lines.	Inspect other appliances near water heater.
	Condensation of flue products.	Refer to "CONDENSATION"
<b>LEAKING T&amp;P VALVE</b>	Thermal expansion in closed water system	Install thermal expansion tank (DO NOT PLUG T&P VALVE)
	Improperly seated valves	Check relief valve for proper operation (DO NOT PLUG T&P VALVE)
<b>HOT WATER ODORS OR COLOR (Refer to ANODE ROD)</b>	High sulfate or mineral content in water supply or iron or sulfate reducing bacteria in water supply	Drain and flush heater thoroughly, chlorinate, refill and flush again then chlorinate water supply.



**! WARNING: DO NOT BY-PASS ANY CONTROLS TO MAKE HEATER OPERATE.  
OPERATE ONLY AS WIRED FROM FACTORY.**

**TROUBLE SHOOTING**

Please check guidelines below. For your safety, water heater service should be performed only by a qualified service technician. Read the GENERAL SAFETY INFORMATION section first.

#	LED STATUS	PROBLEM	SOLUTION
1		The gas control valve/thermostat has sensed inadequate or no earth ground.	<ol style="list-style-type: none"> <li>1 Ensure the wall outlet (power supply) is properly grounded.</li> <li>2 Ensure all ground connections/wires on the water heater are securely connected.</li> </ol>
2		The gas control valve/thermostat has sensed reversed polarity in the 120 VAC power supply.	<ol style="list-style-type: none"> <li>1 Ensure the wall outlet/power supply is properly wired.</li> <li>2 Ensure all internal 120 VAC wiring connections and wiring harness have no reversed wires. 120 VAC "hot" wire must connect to the on/off switch.</li> </ol>
3		<p>Pressure switch circuit remaining closed for more than 5 seconds after heating cycle begins.</p> <p><b>Blower may not start in this condition.</b></p>	<ol style="list-style-type: none"> <li>1 Ensure air pressure switch circuit wiring is correct and the air pressure switch is not jumpered.</li> <li>2 Replace the air pressure switch.</li> </ol>
4		<p>Pressure switch circuit remains open longer than 5 seconds after the blower is energized.</p> <p><b>Blower may run continuously in this condition.</b></p>	<ol style="list-style-type: none"> <li>1 Ensure the air pressure switch sensing tube is properly connected at both ends and is not kinked or damaged.</li> <li>2 Ensure the correct size of vent and intake air pipe (direct vent products) was used per the installation instructions in the manual that came with the water heater.</li> <li>3 Ensure maximum number of elbows or maximum equivalent feet of vent or intake air pipe has not been exceeded per the installation instructions in the manual that came with the water heater.</li> <li>4 Ensure there are no obstructions in the vent or intake air pipe.</li> </ol>
5		The gas control valve/thermostat has detected an open igniter circuit.	<ol style="list-style-type: none"> <li>1 Check wiring to the hot surface igniter assembly - replace igniter assembly if wiring is damaged or worn.</li> <li>2 Check resistance of the igniter at igniter assembly plug - should be between 11 and 18 ohms at room temperature (77° F at plug end) - replace igniter if open or shorted.</li> <li>3 Check igniter assembly plug and the socket on the gas control valve/thermostat for good connection.</li> <li>4 Replace igniter assembly if the plug is worn or damaged.</li> <li>5 Replace the gas control valve/thermostat if the igniter assembly socket on the bottom of the control is worn or damaged.</li> </ol>
6		<p>Ignition/flame failure.</p> <p>The gas control valve/thermostat has reached the maximum number of retries (3) for ignition and is currently locked out for one hour.</p> <p>Cycle the power to the water heater off and on to reset.</p>	<ol style="list-style-type: none"> <li>1 Ensure flame sensor is making good contact with the burner flame and ensure flame is steady. Also ensure supply and manifold gas pressures are within the requirements in the installation manual.</li> <li>2 Gas supply is turned off - pressure is too low.</li> <li>3 Ensure the flame sensor is clean - use fine steel wool to clean the flame sensor.</li> <li>4 Check igniter assembly plug and the socket on the bottom of the gas control valve/thermostat for good connection. Replace igniter assembly if the plug is worn or damaged. Replace the gas control valve/thermostat if socket is worn or damaged.</li> <li>5 Replace igniter assembly.</li> </ol>

#	LED STATUS	PROBLEM	SOLUTION
7		Self diagnostic check has detected a problem with the gas valve driver circuit, internal microprocessor, or other internal circuits.	1 Turn the power off for 10-20 seconds then on again to clear these error codes.  2 If any of these error codes persist or cannot be cleared - replace the gas control valve/thermostat.
8			
9			
10		The gas control valve/thermostat has sensed main burner flame out of proper sequence.	1 Turn the power off for 10-20 seconds then on again to clear these error codes.  2 Replace the gas control valve/thermostat if this error code persists.
11		Water temperature in the tank has exceeded 195° F and has activated the ECO (energy cut off) high temperature limit.	1 Turn the power off for 10-20 seconds then on again to clear these error codes.  2 Replace the gas control valve/thermostat if the error code persists.
12		Self diagnostic check has detected that one or both of the temperature adjust buttons are stuck.	1 Press and release both temperature adjust buttons several times - cycle water heater power off and on.  2 Replace the gas control valve/thermostat if the error code persists.
13		Self diagnostic check has detected the water temperature sensor (located in the control valve's immersion probe) is either open or shorted.	1 Turn the power off for 10-20 seconds then on again to clear these error codes.  2 Replace the gas control valve/thermostat if the error code persists.
14		Self diagnostic check has detected the FV (flammable vapor) sensor is either open or shorted.	1 Turn off power to the water heater. Ensure all FV sensor wiring, the ignitor assembly plug, and the ignitor assembly socket on the bottom of the Intellivent control are making good contact. Repair or replace any worn/damaged components that are not making good connection.  2 Replace the FV sensor.
15		Self diagnostic check has detected the presence of flammable vapors from the FV (flammable vapor) sensor.	1 Do not touch any electrical switch, do not use any phone in your building, and do not try to light any appliance.  2 Smell around the water heater to ensure there are no gas leaks at the gas control valve/thermostat, in the supply gas line(s), or any other type of flammable vapor(s) in the area.  3 Carefully inspect the area surrounding the water heater for any substances such as gasoline, paint, paint thinners, varnish, or cleaners that could emit flammable vapors. Remove anything that can potentially emit flammable vapors from the area and store it properly in a different location.  4 Call the technical information support phone number shown on the water heater labeling for further assistance.
16		The gas control valve/thermostat has detected the air pressure switch circuit is opening repeatedly during one heating cycle.  LDO (Lint, Dust, and Oil) lockout condition.	1 On models equipped with a dilution air intake screen on the blower assembly - check/clean this screen.  2 On models equipped with a combustion air intake screen on the base ring (bottom) of the water heater - check/clean the screen.  3 Ensure intake air screen(s) on models so equipped are not obstructed.

# NOTES

# NOTES

# NOTES



---

**ALL TECHNICAL AND WARRANTY QUESTIONS** SHOULD BE DIRECTED TO THE LOCAL DEALER FROM WHOM THE WATER HEATER WAS PURCHASED. IF YOU ARE UNSUCCESSFUL, CONTACT RESIDENTIAL TECHNICAL ASSISTANCE AT 1-800-527-1953  
COPYRIGHT © 2012, INC. ALL RIGHTS RESERVED.

---